



HUNTER SE

AgileX Robotics Team

User Manual 2021. 11. 30

This chapter contains important safety information; before the robot is powered on for the first time, any individual or organization must read and understand this information before using the device. If you have any questions about use, please contact us at support@agilex.ai. Please follow and implement all assembly instructions and guidelines in the chapters of this manual, which is very important. Particular attention should be paid to the text related to the warning signs.

Safety Information

The information in this manual does not include the design, installation and operation of a complete robot application, nor does it include all peripheral equipment that may affect the safety of the complete system. The design and use of the complete system need to comply with the safety requirements established in the standards and regulations of the country where the robot is installed.

HUNTER SE integrators and end customers have the responsibility to ensure compliance with the applicable laws and regulations of relevant countries, and to ensure that there are no major dangers in the complete robot application. This includes but is not limited to the following:

1. Effectiveness and responsibility

- Make a risk assessment of the complete robot system.
- Connect the additional safety equipment of other machinery defined by the risk assessment together.
- Confirm that the design and installation of the entire robot system's peripheral equipment, including software and hardware systems, are correct.
- This robot does not have the relevant safety functions of a complete autonomous mobile robot, including but not limited to automatic anti-collision, anti-falling, creature approach warning, etc. Relevant functions require integrators and end customers to conduct safety assessment in accordance with relevant provisions and applicable laws and regulations to ensure that the developed robot is free of any major hazards and hidden dangers in practical application.
- Collect all the documents in the technical file: including risk assessment and this manual.

2. Environmental

- For the first use, please read this manual carefully to understand the basic operating content and operating specification.
- It is strictly forbidden to carry people
- For remote control operation, select a relatively open area to use HUNTER SE, because it is not equipped with any automatic obstacle avoidance sensor. Please keep a safe distance of more than 2 meters when

HUNTER SE is moving.

- Use HUNTER SE under $-10^{\circ}\text{C}\sim 45^{\circ}\text{C}$ ambient temperature.
- The waterproof and dust-proof capability of HUNTER SE is IP22.

3. Pre-work Checklist

- Make sure each equipment has sufficient power.
- Make sure the vehicle does not have any obvious defects.
- Check if the remote controller battery has sufficient power.
- When using, make sure the emergency stop switch has been released.

4. Operation

- Make sure the area around is relatively spacious in use.
- Carry out remote control within the range of visibility.
- The maximum load of HUNTERSE is 50KG. When in use, ensure that the payload does not exceed 50KG.
- When installing an external extension, confirm the position of the center of mass of the extension and make sure it is at the center of the vehicle.
- Please charge in time when the equipment is low battery alarm.
- When the equipment has a defect, please immediately stop using it to avoid secondary

damage.

5. Maintenance

- Regularly check the pressure of the tire, and keep the tire pressure at about 2.0 BAR.
- If the tire is severely worn or burst, please replace it in time.
- If the battery is not used for a long time, the battery needs to be charged periodically every 2 to 3 months.
- When the equipment has a defect, please contact the relevant technical to deal with it, and do not handle the defect by yourself.
- Please use it in an environment that meets the requirements of the protection level according to the IP protection level of the equipment.
- When charging, make sure the ambient temperature is above 0° C.

CONTEXT

AgileX Robotics Team.....	1
1. HUNTER SE Introduction.....	6
1.1 Component list.....	6
1.2 Tech specifications.....	6
1.3 Requirement for development.....	8
2. The Basics.....	8
2.1 Status indication.....	10
2.2 Instructions on electrical interfaces.....	10
2.2.1 Instructions on rear electrical interface.....	10
2.3 Instructions on remote control.....	11
2.4 Instructions on control demands and movements.....	11
3. Getting Started.....	12
3.1 Use and operation.....	12
3.2 Charging and battery replacement.....	12
3.3 Development.....	13
3.3.2CAN cable connection.....	20
3.3.3Implementation of CAN command control.....	20
3.4 HUNTERSE ROS Package use example.....	20
4. Precautions.....	23
5. Q&A.....	24
6. Product Dimensions.....	25

1. HUNTER SE Introduction

HUNTERSE is an Ackermann model programmable UGV (UNMANNED GROUND VEHICLE), which is a chassis designed with Ackermann steering, with similar characteristics to cars, and has obvious advantages on ordinary cement and asphalt roads. Compared with the four-wheel differential chassis, HUNTERSE has higher load capacity, can achieve higher movement speed, and at the same time wear less to the structure and tires, suitable for long-term work. Although HUNTERSE is not designed for all-terrain, it is equipped with swing arm suspension and can pass through common obstacles such as speed bumps. Stereo camera, lidar, GPS, IMU, manipulator and other equipment can be optionally installed on HUNTERSE for extended applications. HUNTERSE can be applied to unmanned inspection, security, scientific research, exploration, logistics and other fields.

1.1 Component list

Name	quantity
HUNTER SE robot body	X1
Battery charger (AC 220V)	X1
Aviation plug (4Pin)	X1
FS remote control transmitter (optional)	X1
USB to CAN communication module	X1

1.2 Tech specifications

Parameter Types	Items	Values
Mechanical parameters	L × W × H (mm)	820X 640 X 310
	Wheelbase (mm)	460
	Front/rear wheel base (mm)	550
	Weight of vehicle body (Kg)	42
	Battery type	Lithium battery 24V 30Ah/60Ah
	Power drive motor	DC brush-less 2 X 350W
	Steering drive motor	DC brush-less 105W
	Reduction gearbox	1: 4
	Steering	Front wheel Ackermann
	Encoder	Magnetic encoder 1000
	Maximum inner wheel steering angle	22°
Performance parameters	Safety equipment	Anti-collision beam
	Steering accuracy No-load highest	0.5° 4.8

	speed (m/s) Minimum turning radius (m) Maximum climbing capacity Minimum ground clearance (mm) Operating temperature Load	1.9 20° 120 (through angle 45°) -10~45C° 50kg remote control
Control parameters	Control mode	Remote control Command control mode
	RC transmitter	2.4G/extreme distance 200m
	Communication Interface	CAN

1.3 Requirement for development

FS RC transmitter is provided (optional) in the factory setting of HUNTER SE, which allows users to control the chassis of robot to move and turn; HUNTER SE is equipped with CAN interface, and users can carry out secondary development through it.

1. The Basics

This section will give a basic introduction to the HUNTER SE mobile robot chassis, so that users and developers have a basic understanding of the HUNTER SE chassis. Figures 2.1 and 2.2 below provide the views of the entire mobile robot chassis.

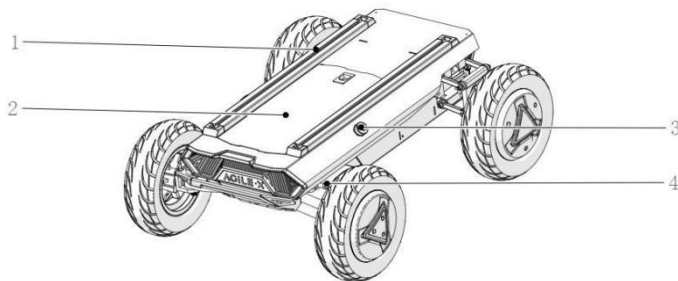

Figure 2.1 Front View

- 1. Profile Support
- 2. Top cabin panel
- 3. Emergency stop button
- 4. Steering mechanism

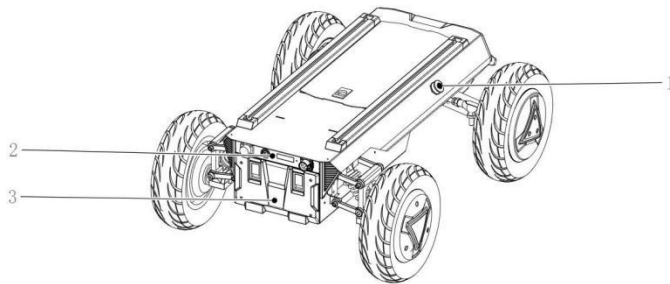

Figure 2.2 Rear View

- 1. Emergency stop switch
- 2. Rear electrical panel
- 3. Battery replacement pane

HUNTER SE adopts a modular and intelligent design concept as a whole. The vacuum rubber wheel and powerful DC brush-less servo motor are used on the power module, which makes the HUNTER SE robot chassis development platform have a strong pass ability. And it is also easy for HUNTER SE to cross obstacles with the front wheel bridge suspension. Emergency stop switches are installed on both sides of the vehicle body, so that emergency stop operations can be performed quickly in the event of an emergency, so as to avoid safety accidents and reduce or avoid unnecessary losses. The rear of HUNTER SE is equipped with an open electrical interface and communication interface, which is convenient for customers to carry out secondary development. The electrical interface adopts aviation waterproof connectors in the design and selection, which is beneficial to the expansion and use of users on the one hand, and enables the robot platform to be used in some harsh environments on the other hand.

2.1 Status indication

Users can identify the status of vehicle body through the voltmeter, the beeper and lights mounted on HUNTERSE. For details, please refer to Figure 2.1.

Status	Description
Current voltage	The current battery voltage can be viewed through the voltmeter in the rear electrical panel.
Low voltage alarm	When the battery voltage is lower than 24.5V, the vehicle body will give a beep-beep-beep sound as a warning. When the battery voltage is detected as lower than 24.5V, HUNTERSE will actively cut off the power supply to external extensions and drive to prevent the battery from being damaged. In this case, the chassis will not enable movement control and accept external command control.

2.2 Instructions on electrical interfaces

2.2.1 Instructions on rear electrical interface

The extension interface at the rear is shown in Figure 2.6, in which Q1 is the charging interface; Q2 is the power switch; Q3 is the power display interaction; Q4 is the CAN and 24V power extension interface.

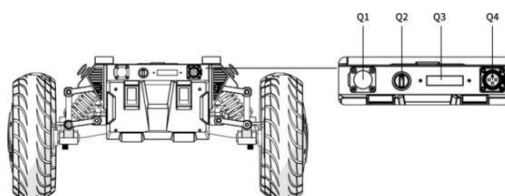

The definition of Q4's specific pin is shown in Figure 2.7.

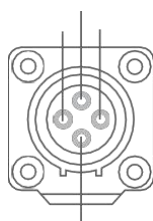

Pin No.	Pin Type	Function and Definition	Remarks
1	Power	VCC	Power positive, voltage range 24.5~26.8v, maximum current 10A
2	Power	GND	Power negative
3	CAN	CAN_H	CAN bus high
4	CAN	CAN_L	CAN bus low

Figure 2.7 Pin Instruction of the Rear Aviation Interface

2.3 Instructions on remote control

FS remote control is an optional accessory for HUNTERSE. Customers can choose according to actual needs. The remote control can easily control the HUNTERSE universal robot chassis. In this product, we use the left-hand throttle design. Refer to Figure 2.8 for its definition and function.

The functions of the buttons are defined as: SWC and SWA are temporarily disabled; SWB is the control mode selection button, dialed to the top is the command control mode, and dialed to the middle is the remote control mode; SWD is the front light switch button; dial it to the top to turn on the light, and dial it to the bottom to turn off the light; S1 is the throttle button, which controls the HUNTER SE forward and backward; S2 controls the steering of the front wheel, while POWER is the power button, and you can turn on the remote control by pressing them at the same time.



Figure 2.8 Schematic diagram of the FS remote control buttons

The functions of the buttons are defined as: SWC and SWA are temporarily disabled; SWB is the control mode selection button, dialed to the top is the command control mode, and dialed to the middle is the remote control mode; SWD is the front light switch button; dial it to the top to turn on the light, and dial it to the bottom to turn off the light; S1 is the throttle button, which controls the HUNTER SE forward and backward; S2 controls the steering of the front wheel, while POWER is the power button, and you can turn on the remote control by pressing them at the same time.

2.4 Instructions on control demands and movements

We set up a coordinate reference system for ground mobile vehicle according to the ISO 8855 standard as shown in Figure 2.9.

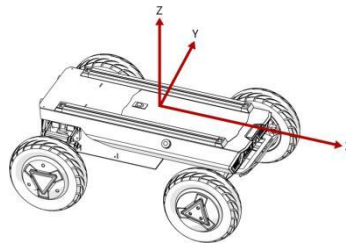

Figure 2.9 Schematic Diagram of Reference Coordinate System for Vehicle Body

As shown in Figure 2.9, the vehicle body of HUNTERSE is in parallel with X axis of the established reference coordinate system. In the remote control mode, push the remote control stick S1 forward to move in the positive X direction, and push S1 backward to move in the negative X direction. When S1 is pushed to the maximum value, the movement speed in the positive X direction is the maximum; when S1 is pushed to the minimum value, the movement speed in the negative X direction is the maximum; the remote control stick S2 controls the steering of the front wheels of the vehicle body; push S2 to the left, and the vehicle turns to the left; push it to the maximum,

and the steering angle is the largest; push S2 to the right, and the vehicle turns to the right; push it to the maximum, and the right steering angle is the largest at this time. In the control command mode, the positive value of the linear velocity means movement in the positive direction of the X axis, and the negative value of the linear velocity means movement in the negative direction of the X axis; the steering angle is the steering angle of the inner wheel.

This section mainly introduces the basic operation and use of the HUNTERSE platform, and how to carry out the secondary development of HUNTERSE through the external CAN interface and the CAN bus protocol.

2. Getting Started

3.1 Use and operation

The basic operation process of the startup operation is as follows:

Check

- Check the condition of HUNTER SE. Check whether there are significant anomalies; if so, please contact the after-sale service personal for support;
- Check the state of emergency-stop switches. Make sure the emergency stop buttons are released;
- When using for the first time, make sure that Q2 (knob switch) in the rear electrical panel is vertical, and the HUNTERSE is in a power-off state at this time.

Startup

- Turn the knob switch to the horizontal state (Q2); under normal circumstances, the voltmeter normally

displays the battery voltage;

- Check the battery voltage, and the normal voltage range is 24.5~26.8V; if there is a continuous "beep-beep-beep..." sound from the beeper, it means that the battery voltage is too low, then please charge it in time.

Shutdown

- Turn the knob switch to vertical to cut off the power.

Emergency stop

- Press the emergency stop switch on the side of the HUNTERSE vehicle body.

Basic operating procedures of remote control

- After the HUNTERSE mobile robot chassis is started correctly, turn on the RC transmitter and set SWB to the remote control mode. Then, HUNTERSE platform movement can be controlled by the RC transmitter.

3.2 Charging and battery replacement

HUNTER SE is equipped with a 10A charger by default, which can meet the charging needs of customers. When charging normally, there is no description of the indicator light on the chassis. For specific instructions, please refer to the description of the charger indicator light.

The specific operating procedures of charging are as follows:

- Make sure that the HUNTER SE chassis is in a shutdown state. Before charging, please make sure that the power switch in the rear electrical console is turned off;
- Insert the plug of the charger into the Q1 charging interface in the rear electrical control panel;

- Connect the charger to the power supply and turn on the charger switch to enter the charging state.

Note: For now, the battery needs about 3 hours to be fully recharged from 24.5V, and the voltage of a fully recharged battery is about 26.8V;

Battery replacement

- Turn off the power switch of the HUNTERSE chassis
- Press the button lock on the battery replacement panel to open the battery panel
- Unplug the currently connected battery interface, respectively (XT60 power connector)
- Take out the battery, and pay attention that the battery is not allowed to be bumped and collided during this process

3.3 Development

The CAN communication standard in HUNTER SE adopts CAN2.0B standard, the communication baud rate is 500K, and the message format adopts MOTOROLA format. The linear velocity and steering angle of the chassis movement can be controlled through the external CAN bus interface; HUNTER SE will feedback the current movement status information and the status information of the HUNTER chassis in real time. The system status feedback command includes current vehicle body status feedback, control mode status feedback, battery voltage feedback and fault feedback. The protocol content is shown in Table 3.1.

Table 3.1 Feedback Frame of HUNTER SE Chassis System Status

Command Name	System Status Feedback Command			
Sending node	Receiving node	ID	Cycle (ms)	Receive time-out (ms)
Steer-by-wire chassis	Decision-making control unit	0x211	100ms	None
Data length	0x08			
Position	Function	Data type	Description	
byte [0]	Current status of vehicle body	unsigned int8	0x00 System in normal condition 0x01 Emergency stop mode 0x02 System exception	
byte [1]	Mode control	unsigned int8	0x00 Standby mode 0x01 CAN command control mode 0x02 Remote control mode	
byte [2] byte [3]	The battery voltage is 8 bits higher The battery voltage is 8 bits lower	unsigned int16	Actual voltage × 10 (with an accuracy of 0.1V)	
byte [4] byte [5]	The failure information is 8 bits higher The failure information is 8 bits lower	unsigned int16	Refer to remarks [Description of Failure Information]	
byte [6]	Reserved	—	0x00	
byte [7]	Count check (count)	unsigned int8	0~255 cycle count; every time an instruction is sent, the count will increase once	

Description of Fault		
byte	Bit	Meaning
byte [4]	bit [0]	Reserved, default 0
	bit [1]	Reserved, default 0
	bit [2]	Remote control disconnection protection (0: No failure 1: Failure)
	bit [3]	Reserved, default 0
	bit [4]	Upper layer communication connection (0: No failure 1: Failure)
	bit [5]	Reserved, default 0
	bit [6]	Drive status error (0: No failure 1: failure)
	bit [7]	Reserved, default 0
byte [5]	bit [0]	Battery under-voltage failure (0: No failure 1: Failure)
	bit [1]	Steering zero setting error (0: No failure 1: Failure)
	bit [2]	Reserved, default 0
	bit [3]	Steering motor driver communication failure (0: No failure 1: Failure)
	bit [4]	Rear right motor driver communication failure (0: No failure 1: Failure)
	bit [5]	Rear left motor driver communication failure (0: No failure 1: Failure)
	bit [6]	Motor overheat failure (0: No failure 1: failure)
	bit [7]	Drive over-current failure (0: No failure 1: failure)

The command of movement control feedback frame includes the feedback of current linear velocity and steering angle of moving vehicle body. The specific protocol content is shown in Table 3.2.

Table 3.2 Movement Control Feedback Frame

Command Name	System Status Feedback Command			
Sending node	Receiving node	ID	Cycle (ms)	Receive time-out (ms)
Steer-by-wire chassis	Decision-making control uni	0x221	20ms	none
Data length	0x08			
Position	Function	Data type	Description	
byte [0] byte [1]	The movement speed is 8 bits higher The movement speed is 8 bits lower	signed int16	Actual speed × 1000 (with an accuracy of 0.001m/s)	
byte [2]	Reserved		0x00	
byte [3]	Reserved		0x00	

byte [4]	Reserved		0x00
byte [5]	Reserved		0x00
byte [6] byte [7]	The angle is 8 bits higher The angle is 8 bits lower	Signed int16	Actual inner angle X1000 (unit: 0.001rad)

The movement control frame includes the linear velocity control command and the front wheel inner angle control command. The specific protocol content is shown in Table 3.3.

Table 3.3 Movement Control Feedback Frame

Command Name	System Status Feedback Command			
Sending node	Receiving node	ID	Cycle (ms)	Receive time-out (ms)
Decision-making control unit	Chassis node	0x111	20ms	500ms
Data length	0x08			
Position	Function	Data type	Description	
byte [0] byte [1]	The linear velocity is 8 bits higher The linear velocity is 8 bits lower	signed int16	Moving speed of vehicle body, unit: mm/s (effective value: +4800)	
byte [2]	Reserved	—	0x00	
byte [3]	Reserved	—	0x00	
byte [4]	Reserved	—	0x00	
byte [5]	Reserved	—	0x00	
byte [6] byte [7]	The angle is 8 bits higher The angle is 8 bits lower	signed int16	Steering inner angle unit: 0.001rad (effective value +400)	

PS: In the CAN command mode, it is necessary to ensure that the 0X111 command frame is sent in a period less than 500MS (recommended period is 20MS), otherwise HUNTER SE will judge that the control signal is lost and

enter an error (0X211 feedback that the upper layer communication is lost). After the system reports an error, it will enter the standby mode. If the 0X111 control frame returns to the normal sending period at this time, the upper layer communication disconnection error can be automatically cleared, and the control mode returns to the CAN control mode.

The mode setting frame is used to set the control interface of HUNTER SE. The specific protocol content is shown in Table 3.4.

Table 3.4 Control Mode Setting Command

Command Name	System Status Feedback Command			
Sending node	Receiving node	ID	Cycle (ms)	Receive time-out (ms)
Decision-making control unit	Chassis node	0x421	none	none
Data length	0x01			
Position	Function	Data type	Description	
byte [0]	Control mode	unsigned int8	0x00 Standby mode 0x01 CAN指令模式上电默认进入待机模式0x01 Power on in	

Description of control mode: In case the HUNTERSE is powered on and the RC transmitter is not connected, the control mode is defaulted to standby mode. At this time, the chassis only receives control mode command, and does not respond to other commands. To use CAN for control, you need to switch to CAN command mode at first. If the RC transmitter is turned on, the RC transmitter has the highest authority, can shield the control of command and switch the control mode.

The status setting frame is used to clear system errors. The protocol content is shown in Table 3.5.

Table 3.5 Status Setting Frame

Command Name	System Status Feedback Command			
Sending node	Receiving node	ID	Cycle (ms)	Receive time-out (ms)
Decision-making control unit	Chassis node	0x441	none	none
Data length	0x01			
Position	Function	Data type	Description	

byte [0]	error clearing command	unsigned int8	<p>0xFF Clear all non-critical failures</p> <p>0x04 Clear the communication failure of the steering motor driver</p> <p>0x05 Clear the communication failure of the rear right motor driver</p> <p>0x06 Clear the communication failure of the rear left motor driver</p>
----------	------------------------	---------------	---

[Note] Sample data, the following data is only for testing

1. The vehicle moves forward at a speed of 0.15m/S

byte [0]	byte [1]	byte [2]	byte [3]	byte [4]	byte [5]	byte [6]	byte [7]
0x00	0x96	0x00	0x00	0x00	0x00	0x00	0x00

2. The vehicle steering 0.2rad

byte [0]	byte [1]	byte [2]	byte [3]	byte [4]	byte [5]	byte [6]	byte [7]
0x00	0x00	0x00	0x00	0x00	0x00	0x00	0xC8

The chassis status information will be feedback, and what's more, the information about motor current, encoder and temperature are also included. The following feedback frame contains the information about motor current, encoder and motor temperature.

The corresponding motor numbers of the three motors in the chassis are: steering No. 1, right rear wheel No. 2, left rear wheel No. 3

The motor speed current position information feedback is shown in Table 3.6 and 3.7.

Table 3.6 Motor Drive High Speed Information Feedback Frame

Command Name		Motor Drive High Speed Information Feedback Frame		
Sending node	Receiving node	ID	Cycle (ms)	Receive time-out (ms)
Steer-by-wire chassis	Decision-making control unit 0x08	0x251~0x253	20ms	None
Data length	Function	Data type	Description	
byte [0] byte [1]	The motor speed is 8 bits higher The motor speed	signed int16	Current motor speed Unit RPM	

	is 8 bits lower		
byte [2] byte [3]	The motor current is 8 bits higher The motor current is 8 bits lower	signed int16	Motor current Unit 0.1A
byte [4] byte [5] byte [6] byte [7]	Reserved	--	0×00

Table 3.7 Motor Drive Low Speed Information Feedback Frame

Command Name Motor Drive Low Speed Information Feedback Frame				
Sending node	Receiving node	ID	Cycle (ms)	Receive time-out (ms)
Steer-by-wire chassis	Decision-making control unit	0x261~0x263	100ms	None
Data length	0x08			
Position	Function	Data type	Description	
byte [0] byte [1]	The drive voltage is 8 bits higher The drive voltage is 8 bits lower	unsigned int16	Current drive voltage Unit 0.1V	
byte [2] byte [3]	The drive temperature is 8 bits higher The drive temperature is 8 bits lower	signed int16	Unit 1℃	
byte [4]	Motor temperature	signed int8	Unit 1℃	
byte [5]	Drive status	unsigned int8	See the details in [Drive control status]	
byte [6]	Reserved	—	0x00	
byte [7]	Reserved	—	0x00	

The specific content of the drive status information is shown in Table 3.8.

Table 3.8 Drive Status Description

Drive Status		
Byte	Bit	Description
	bit [0]	Whether the power supply voltage is too low (0: Normal 1: Too low)
	bit [1]	Whether the motor is overheated (0: Normal 1: Overheated)
	bit [2]	Whether the drive is over current (0: Normal 1: Over current)
	bit [3]	Whether the drive is overheated (0: Normal 1: Overheated)
	bit [4]	Sensor status (0: Normal 1: Abnormal)
	bit [5]	Drive error status (0: Normal 1: Error)
byte [5]	bit [6]	Drive enable status (0: Enable 1: Disable)
	bit [7]	Reserved

Steering zero setting and feedback commands are used to calibrate the zero position. The specific contents of the protocol are shown in Table 3.10 and 3.11.

Table 3.10 Steering Zero Setting Command

Command Name	Steering Zero Query			
Sending node	Receiving node	ID	Cycle (ms)	Receive time-out (ms)
Steer-by-wire chassis	Decision-making control uni	0x432	None	none
Data length	0x01			
Position	Function	Data type	Description	
byte [0]	The zero offset is 8 bits higher	signed int16	Zero offset value pulse number reference value 22000+-10000	
byte [1]	The zero offset is 8 bits lower			

Table 3.11 Steering Zero Setting Feedback Command

Command Name	Steering Zero Query			
Sending node	Receiving node	ID	Cycle (ms)	Receive time-out (ms)
Steer-by-wire chassis	Decision-making control uni	0x43 B	None	none
Data length	0x01			
Position	Function	Data type	Description	
byte [0]	The zero offset is 8 bits higher	signed int16	he chassis will use the default value beyond the settable range 22000	
byte [1]	The zero offset is 8 bits lower			

Table 3.12 Steering Zero Query Command

Command Name	Steering Zero Query			
Sending node	Receiving node	ID	Cycle (ms)	Receive time-out (ms)
Decision-making control uni	Steer-by-wire chassis	0x433	None	none
Data length	0x01			
Position	Function	Data type	Description	
byte [0]	Query the current zero offset value	unsigned int8	Fixed value: 0×AA The query successfully returns 0×43B	

3.3.2 CAN cable connection

HUNTER SE is shipped with a aviation plug male connector as shown in Figure 3.2. Refer to Table 3.2 for the definition of the cable.



3.3.3 Implementation of CAN command control

Start the HUNTERSE mobile robot chassis normally, turn on the FS remote control, and then switch the control mode to command control, that is, turn the SWB mode selection of the FS remote control to the top. At this time, the HUNTERSE chassis will accept the command from the CAN interface, and the host can also analyze the current status of the chassis through the real-time data fed back by the CAN bus at the same time. Refer to CAN communication protocol for specific protocol content.

3.4 HUNTERSE ROS Package use example

ROS provides some standard operating system services, such as hardware abstraction, low-level equipment control, implementation of common functions, inter-process message and data packet management. ROS is based on a graph architecture, so that processes of different nodes can receive, release, and aggregate various information (such as sensing, control, status, planning, etc.). Currently ROS mainly supports UBUNTU.

Hardware preparation

- CANlight can communication module X1
- Thinkpad E470 notebook X1
- AGILEX HUNTER SE mobile robot chassis X1
- AGILEX HUNTER SE supporting remote control FS-i6s X1
- AGILEX HUNTER SE rear aviation socket X1

Use example environment description

- Ubuntu 16.04 LTS (This is a test version, tested on Ubuntu 18.04 LTS)
- ROS Kinetic (Subsequent versions are also tested)
- Git

Hardware connection and preparation

- Lead out the CAN cable of the HUNTER SE tail plug, and connect CAN_H and CAN_L in the CAN cable to the CAN_TO_USB adapter respectively;
- Turn on the knob switch on the HUNTER SE mobile robot chassis, and check whether the emergency stop switches on both sides are released;
- Connect the CAN_TO_USB to the usb interface of the notebook. The connection diagram is shown in Figure 3.4.

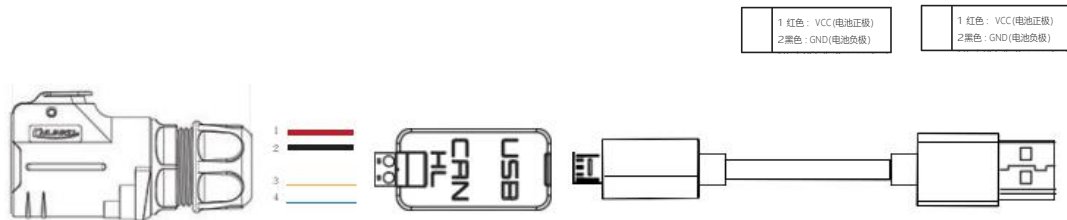

Figure 3.4 CAN Connection Diagram

ROS installation

- For installation details, please refer to <http://wiki.ros.org/kinetic/Installation/Ubuntu>

Hardware and CAN communication

- Set CAN-TO-USB adaptor
- Enable `gs_usb` kernel module
`$ sudo modprobe gs_usb`
- Set 500k baud rate and enable can-to-usb adaptor
`$ sudo ip link set can0 up type can bitrate 500000`
- If no error occurred in the previous steps, you should be able to use the command to view the can equipment immediately
`$ ifconfig -a`
- Install and use `can-utils` to test hardware
`$ sudo apt install can-utils`
- If the `can-to-usb` has been connected to the HUNTER SE robot this time, and the vehicle has been turned on, use the following commands to monitor the data from the HUNTER SE chassis
`$ candump can0`
- Reference sources:
[1] https://github.com/agilexrobotics/agx_sdk
[2] https://wiki.rdu.im/_pages/Notes/Embedded-System/Linux/can-bus-in-linux.html

HUNTER SE ROS PACKAGE download and compile

- Download ros dependent package
`$ sudo apt install libasio-dev`
`$ sudo apt install ros-$ROS_DISTRO-teleop-twist-keyboard`
- Clone and compile `hunter_2_ros` source code
`$ cd ~/catkin_ws/src`
`$ git clone --recursive https://github.com/agilexrobotics/ugv_sdk.git`
`$ git clone https://github.com/agilexrobotics/hunter_ros.git`
`$ cd ..`
`$ catkin_make`
- Reference source:
https://github.com/agilexrobotics/hunter_ros

Start the ROS nodes

- Start the base node
`$ roslaunch hunter_bringup hunter_robot_base.launch`
- Start the keyboard remote operation node
`$ roslaunch hunter_bringup hunter_teleop_keyboard.launch`

3. Precautions

This section includes some precautions that should be paid attention to for HUNTER SE use and development.

Battery

- The battery supplied with HUNTER SE is not fully charged in the factory setting, but its specific power capacity can be displayed on the voltmeter at rear end of HUNTER SE chassis or read via CAN bus communication interface. The battery recharging can be stopped when the green LED on the charger turns green. Note that if you keep the charger connected after the green LED gets on, the charger will continue to charge the battery with about 0.1A current for about 30 minutes more to get the battery fully charged.
- Please do not charge the battery after its power has been depleted, and please charge the battery in time when low battery level alarm is on;
- Static storage conditions: The best temperature for battery storage is -10°C to 45°C ; in case of storage for no use, the battery must be recharged and discharged once about every 2 months, and then stored in full voltage state. Please do not put the battery in fire or heat up the battery, and please do not store the battery in
- high-temperature environment;
- Charging: The battery must be charged with a dedicated lithium battery charger. Do not charge the battery below 0°C , and do not use batteries, power supplies, and chargers that are not standard.
- HUNTER SE only supports the replacement and use of the battery provided by us, and the battery can be charged separately.

Operational

- The operating temperature of HUNTER SE is -10°C to 45°C ; please do not use it below -10°C or above 45°C ;
- The requirements for relative humidity in the operational environment of HUNTER SE are: maximum 80%, minimum 30%;
- Please do not use it in the environment with corrosive and flammable gases or closed to

combustible substances;

- Do not store it around heating elements such as heaters or large coiled resistors;
- HUNTER SE is not water-proof, thus please do not use it in rainy, snowy or water-accumulated environment;
- It is recommended that the altitude of the operational environment should not exceed 1000M;
- It is recommended that the temperature difference between day and night in the operational environment should not exceed 25°C ;

Electrical external extension

- For the extended power supply at rear end, the current should not exceed 10A and the total power should not exceed 240W;
- When the system detects that the battery voltage is lower than the safe voltage, external power supply extensions will be actively switched off. Therefore, users are suggested to notice if external extensions involve the storage of important data and have no power-off protection.

Other notes

- When handling and setting up, please do not fall off or place the vehicle upside down;
- For non-professionals, please do not disassemble the vehicle without permission.

4. Q&A

Q: HUNTER SE is started up correctly, but why cannot the RC transmitter control the vehicle body to move?

A: First, check whether the vehicle's power supply is in normal condition, and whether E-stop switches are released; then, check whether the control mode selected with the top left mode selection switch on the RC transmitter is correct.

Q: HUNTER SE remote control is in normal condition, and the information about chassis status and movement can be received correctly, but when the control frame protocol is issued, why cannot the vehicle body control mode be switched and the chassis respond to the control frame protocol?

A: Normally, if HUNTER SE can be controlled by a RC transmitter, it means the chassis movement is under proper control; if the chassis feedback frame can be received, it means CAN extension link is in normal condition. Please check the CAN control frame sent to see whether the data check is correct and whether the control mode is in command control mode. You can check the status of error flag from the error bit in the chassis status feedback frame.

Q: HUNTER SE gives a "beep-beep-beep..." sound in operation; how to deal with this problem?

A: If HUNTER SE gives this "beep-beep-beep" sound continuously, it means the battery is in the alarm voltage state. Please charge the battery in time.

5. Product Dimensions

6.1 Illustration diagram of product external dimensions

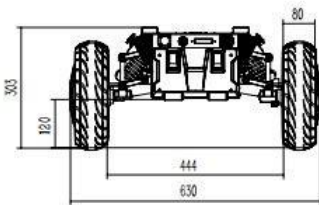
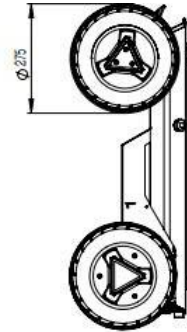
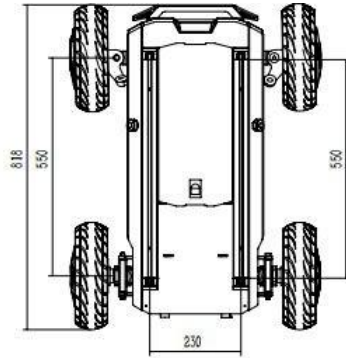

6.2 Illustration diagram of top extended support dimensions

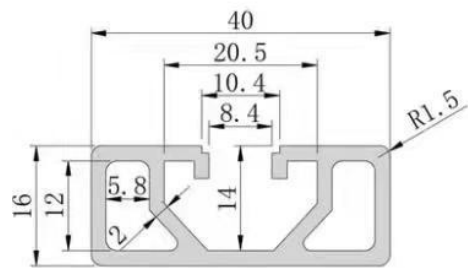
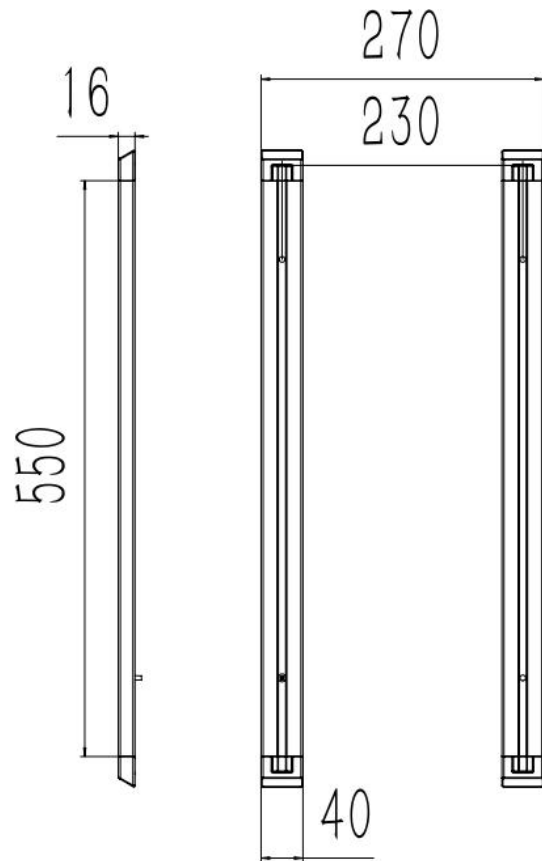

型号:ZEN-OB1640Q 米重:0.78kg/m 壁厚:2mm

Model: ZEN-OB1640Q

Weight per meter: 0.78kg/m

Wall thickness: 2mm

AGILE·X

AgileX Robotics (Dongguan) CO., Ltd.

WWW.AGILEX.AI

TEL:+86-769-22892150

MOBILE: +86-19925374409

